

REV	DESCRIPTION	DATE
A	INITIAL RELEASE	25-03-2021
B	INCORPORATED ECN-216-006 REV A, ADDED -013 CONFIGURATION	12-02-2024
C	ADDED -015 CONFIGURATION.	08-10-2024

_____ NEW WIRE / UNIT
 - - - - - EXISTING WIRE / UNIT

NOTES:

- PERFORM ALL WORK IN ACCORDANCE WITH BELL HELICOPTER STANDARD PRACTICES MANUAL BHT-ELEC-SPM.
- ALL NEW UNSHIELDED WIRE USE M22759/41-(XX)-9 OR EQUIVALENT TYPE WIRE. (M22759/41-(XX)-9 IS NOT INTENDED TO BE USED IN SOLDER APPLICATIONS, SOLDERABILITY CAN BE ACHIEVED WITH THE PROPER SOLDER. USE CRIMP SPLICES FOR REPAIR). ALL WIRES 22 AWG UNLESS OTHERWISE SPECIFIED BY WIRE CODE. ALL JUMPERS TO BE LESS THAN 6 INCHES.
- ALL NEW SHIELDED WIRE USE M27500-(XX)SM(X)N23 OR EQUIVALENT TYPE WIRE. (M27500-(XX)SM(X)N23 IS NOT INTENDED TO BE USED IN SOLDER APPLICATIONS, SOLDERABILITY CAN BE ACHIEVED WITH THE PROPER SOLDER. USE CRIMP SPLICES FOR REPAIR). SOLDER SLEEVES SHALL USE SN96 SOLDER, USE P/N S200-X-00 OR EQUIVALENT.
- ALL SHIELD TERMINATIONS SHALL BE INSTALLED PER MIL-S-83519 OR EQUIVALENT. SHIELD TERMINATIONS SHOWN AS "DAISY-CHAINED" ARE FOR DRAWING CLARITY ONLY. INDIVIDUAL SHIELD EXTENSIONS SHALL BE SPLICED AT A COMMON TIE POINT TO THE TERMINATING WIRES. THE BACK SHELL OR AIRFRAME GROUND MAY BE USED.
- ALL AIRFRAME GROUNDS SHALL BE VIA AMP LUG OR GROUNDING BLOCK AND PROVIDE SEPARATE GROUND STUD LOCATIONS FOR DC POWER GROUNDS, AC POWER GROUNDS, CHASSIS GROUNDS, SIGNAL GROUNDS AND SHIELD GROUNDS.
- ALL EQUIPMENT BONDING TO ADJACENT AIRFRAME STRUCTURE TO BE 0.0025 OHM OR LESS. ALL ELECTRICAL GROUNDING AND BONDING TO BE INSTALLED IN ACCORDANCE WITH THE LATEST REVISION OF BHT-ELEC-SPM CHAPTER 8.
- ALL TERMINALS TO BE INSTALLED IN ACCORDANCE WITH THE LATEST REVISION OF BHT-ELEC-SPM CHAPTER 4 PARAGRAPH 4-9.
- ALL CONNECTORS TO BE INSTALLED IN ACCORDANCE WITH THE LATEST REVISION OF BHT-ELEC-SPM CHAPTER 5 AND / OR CIRCULAR CONNECTOR INSTALLATION INSTRUCTIONS (GARMIN DOCUMENT 190-00313-12). ENSURE ALL UNUSED CONNECTOR CONTACTS ARE FILLED WITH SPARE PINS/SOCKETS OR PLASTIC GROMMET SEALING PLUGS. ENSURE ALL BULKHEAD MOUNTED CONNECTORS ARE PROPERLY BONDED TO AIRFRAME.
- ENSURE ALL SWITCHES, CIRCUIT BREAKERS, AND REMOTE MOUNTED BOXES ARE LABELED WITH A CONSISTENT SIZE, FONT, COLOR, BACKGROUND AND ARE ILLUMINATED CONSISTENT AS EXISTING LABELS.
- ROUTE ALL WIRES AND CABLES WITH EXISTING WIRE ROUTES WHERE POSSIBLE AND CLAMP IN ACCORDANCE WITH THE LATEST REVISION OF BHT-ELEC-SPM CHAPTER 6. WIRES MUST BE ROUTED WITH A MINIMUM OF 6 INCHES OF SEPARATION FROM OXYGEN AND FLUID LINES (MIN 2 INCHES IF WIRES IN CONDUIT).
- INSTALL SYSTEM IN ACCORDANCE WITH THE LATEST REVISION OF THE MANUFACTURERS INSTALLATION MANUAL.
- LOWERCASE LETTER CONNECTOR PIN DESIGNATORS ARE SHOWN AS UNDERLINED UPPERCASE LETTERS.
- POWER WIRES NOT TO EXCEED 200 FT.
- INCLUDED IN KIT PN: 9017646
- INSTALL THE PITOT STATIC SYSTEM IN ACCORDANCE WITH PITOT STATIC INSTALLATION DRAWING E2006-01-17 REV A OR LATER APPROVED REVISION.

4	4	4	7	9017642	CONNECTOR, PNEUMATIC	MIDCONTINENT
2	2	2	6	9017274	BACKSHELL COVER	MIDCONTINENT
15	2	2	5	901718	BACKSHELL	MIDCONTINENT
15	2	2	4	9016479	15-PIN D-SUB	MIDCONTINENT
15	2	2	3	9017275	CONFIGURATION MODULE	MIDCONTINENT
15	2	2	2	MS22073-1	CIRCUIT BREAKER, 1A	MIL SPEC
15	2	2	1	6420302-7	STANDBY ATTITUDE MODULE	MIDCONTINENT
				-013	STANDBY ATTITUDE MODULE	
				-013	STANDBY ATTITUDE MODULE	
				-011	STANDBY ATTITUDE MODULE	
-015 QTY	-013 QTY	-011 QTY	ITEM	PART NUMBER	DESCRIPTION	REMARKS

BILL OF MATERIALS

PREPARED	NF	 <p>COPYRIGHT ©2024 BY EAGLE COPTERS MAINTENANCE LTD THIS DOCUMENT IS PRIVATE AND CONFIDENTIAL AND IS SUPPLIED ON THE EXPRESS CONDITION THAT IT IS NOT TO BE USED FOR ANY PURPOSE OR COPIED OR COMMUNICATED TO ANY OTHER PERSON WITHOUT WRITTEN PERMISSION FROM EAGLE COPTERS MAINTENANCE LTD.</p>
REVIEWED	CP	
RELEASED	JP	
SCALE:	NTS	
TITLE:		DWG:
WIRING DIAGRAM		E2006-11-13
STANDBY ATTITUDE MODULE		REV: C
B212		SHEET: 1 OF 4

D

D

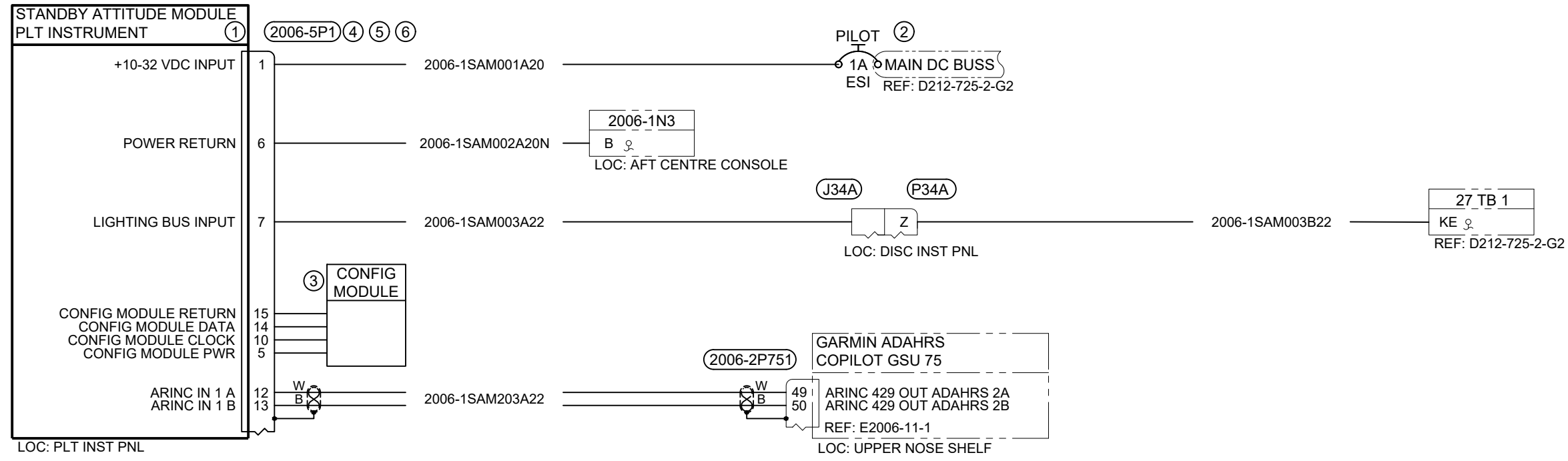

C

C

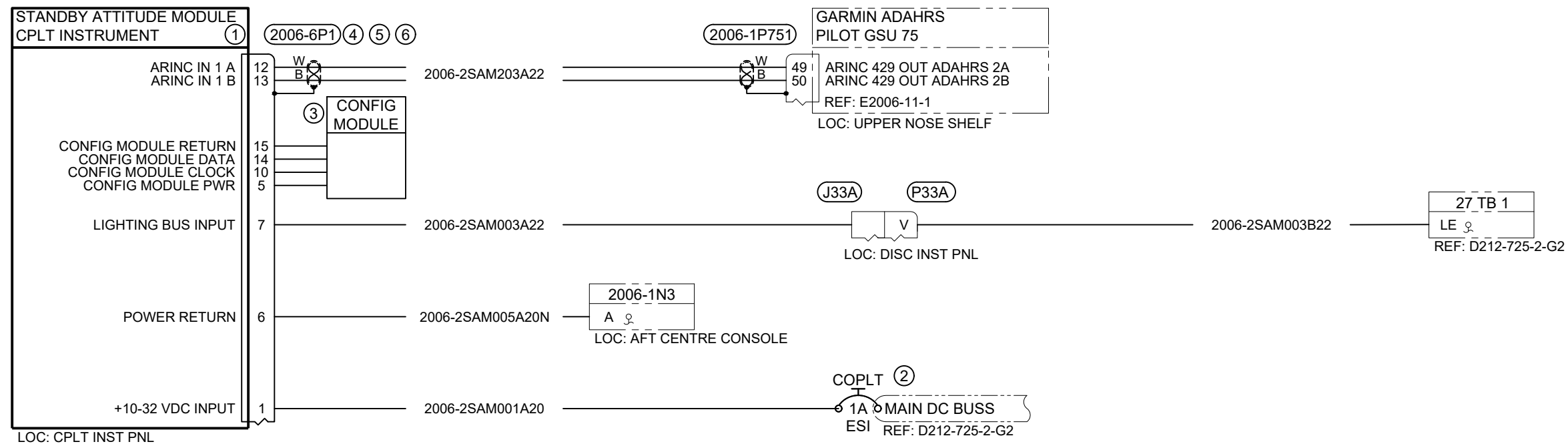

B

B

A

A

-011 STANDBY ATTITUDE MODULE

TITLE: WIRING DIAGRAM		
STANDBY ATTITUDE MODULE		
B212		
DWG: E2006-11-13	REV: C	SHEET: 2 OF 4
COPYRIGHT © 2024 BY EAGLE COPTERS MAINTENANCE LTD THIS DOCUMENT IS PRIVATE AND CONFIDENTIAL AND IS SUPPLIED ON THE EXPRESS CONDITION THAT IT IS NOT TO BE USED FOR ANY PURPOSE OR COPIED OR COMMUNICATED TO ANY OTHER PERSON WITHOUT WRITTEN PERMISSION FROM EAGLE COPTERS MAINTENANCE LTD.		

D

D

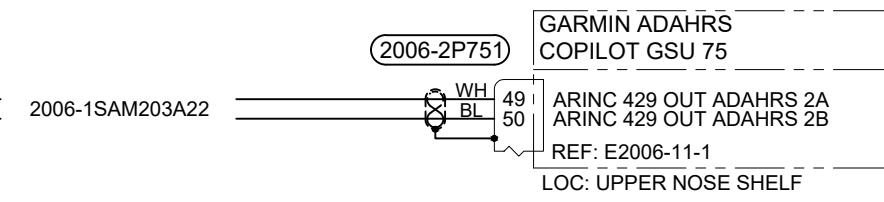
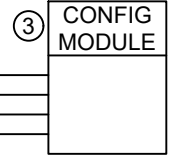
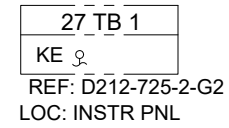
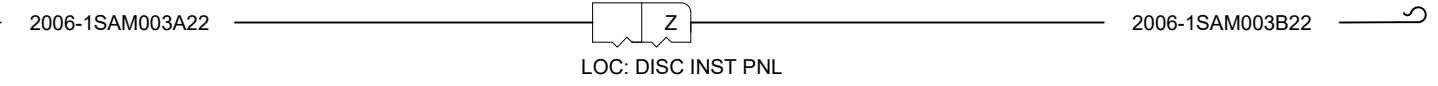
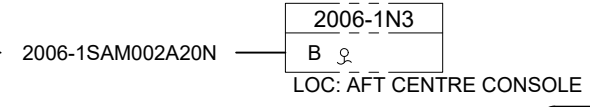
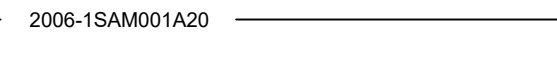
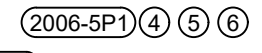
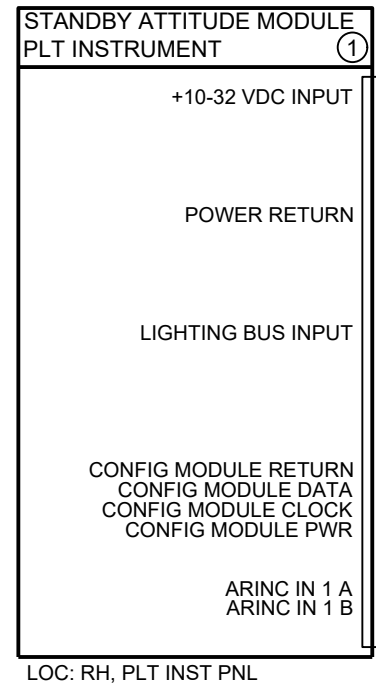

C

C

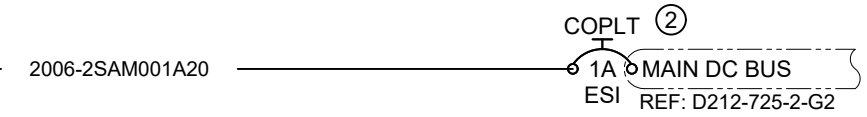
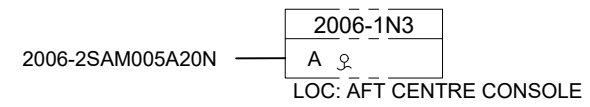
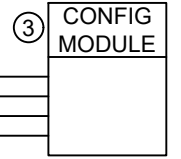
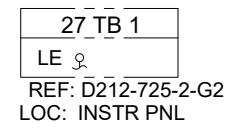
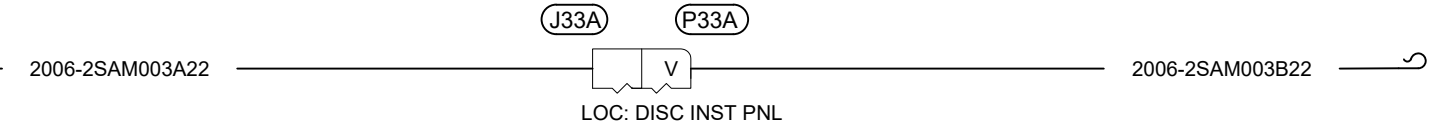
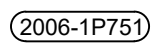
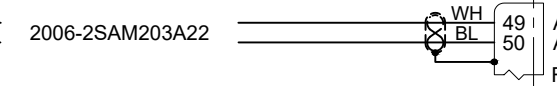
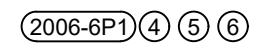
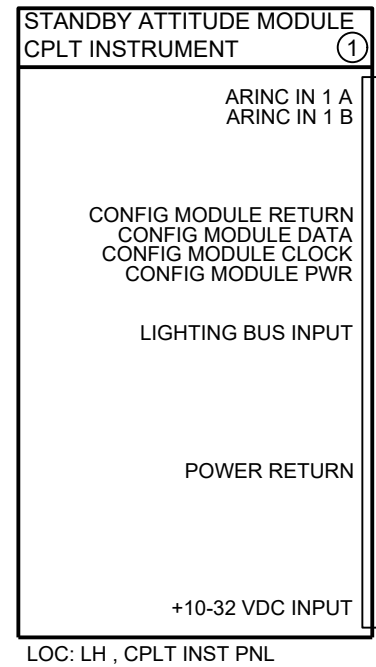

B

B

A

A

TITLE: WIRING DIAGRAM		
STANDBY ATTITUDE MODULE		
B212		
DWG: E2006-11-13	REV: C	SHEET: 3 OF 4
COPYRIGHT © 2024 BY EAGLE COPTERS MAINTENANCE LTD THIS DOCUMENT IS PRIVATE AND CONFIDENTIAL AND IS SUPPLIED ON THE EXPRESS CONDITION THAT IT IS NOT TO BE USED FOR ANY PURPOSE OR COPIED OR COMMUNICATED TO ANY OTHER PERSON WITHOUT WRITTEN PERMISSION FROM EAGLE COPTERS MAINTENANCE LTD.		

-013 STANDBY ATTITUDE MODULE

D

D

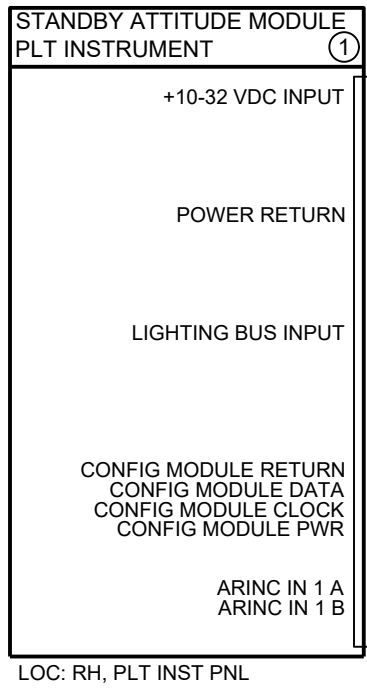

2006-5P1 ④ ⑤ ⑥

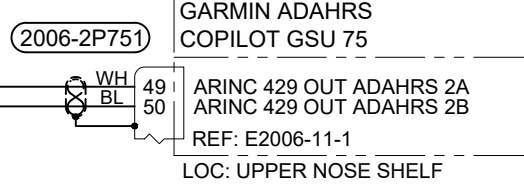
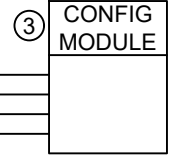
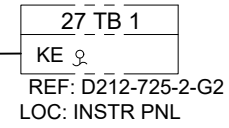
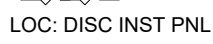
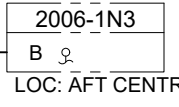
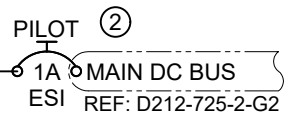

C

C

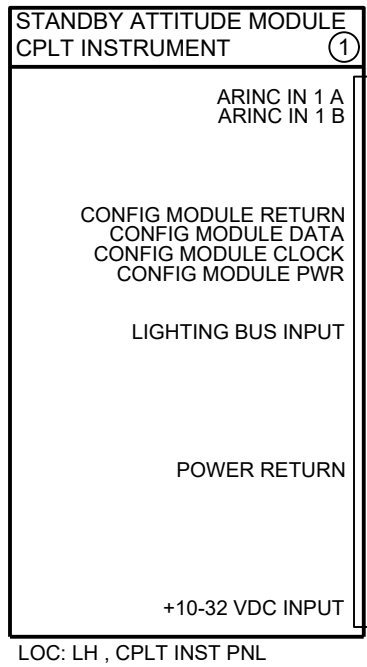

2006-6P1 ④ ⑤ ⑥

2006-1P751

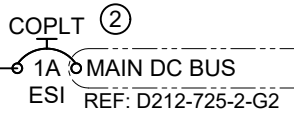
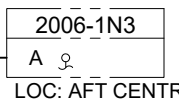
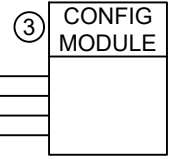
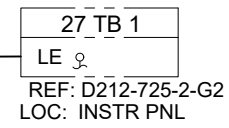
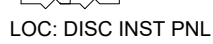
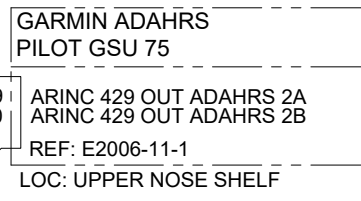

B

B

A

A

-015 STANDBY ATTITUDE MODULE

TITLE: WIRING DIAGRAM		
STANDBY ATTITUDE MODULE		
B212		
DWG: E2006-11-13	REV: C	SHEET: 4 OF 4
<small>COPYRIGHT © 2024 BY EAGLE COPTERS MAINTENANCE LTD THIS DOCUMENT IS PRIVATE AND CONFIDENTIAL AND IS SUPPLIED ON THE EXPRESS CONDITION THAT IT IS NOT TO BE USED FOR ANY PURPOSE OR COPIED OR COMMUNICATED TO ANY OTHER PERSON WITHOUT WRITTEN PERMISSION FROM EAGLE COPTERS MAINTENANCE LTD.</small>		